

As telleiras

Debuxos de Mon Daporta
(de 1983 a 2010)

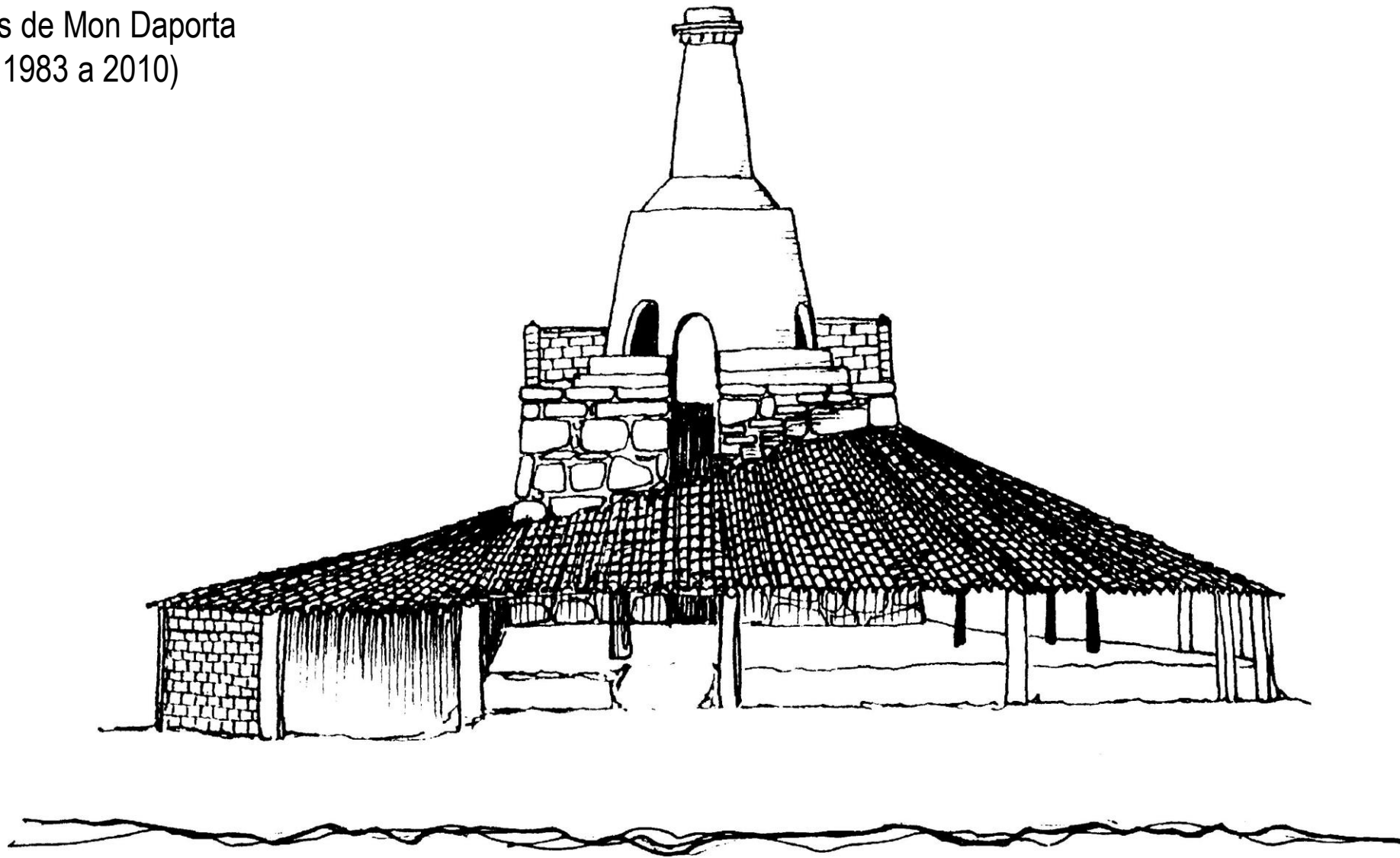

PARTES DUNHA TELLEIRA

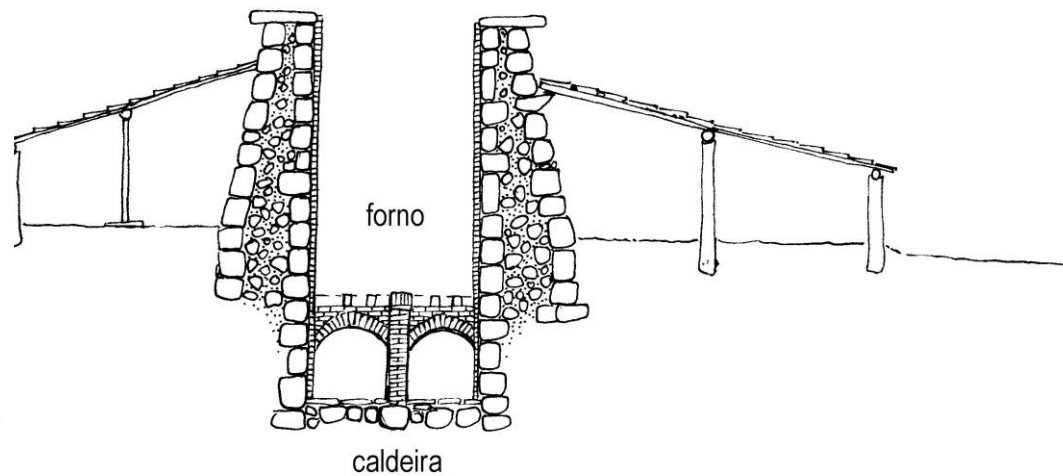
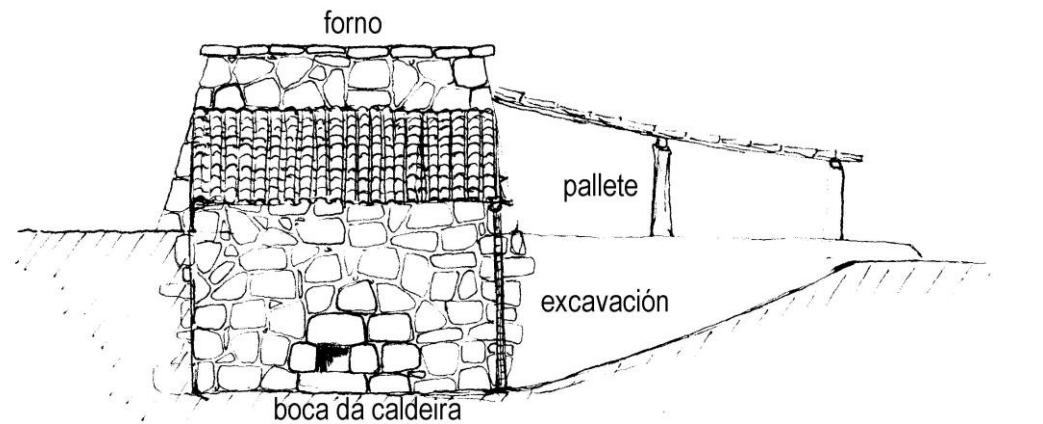
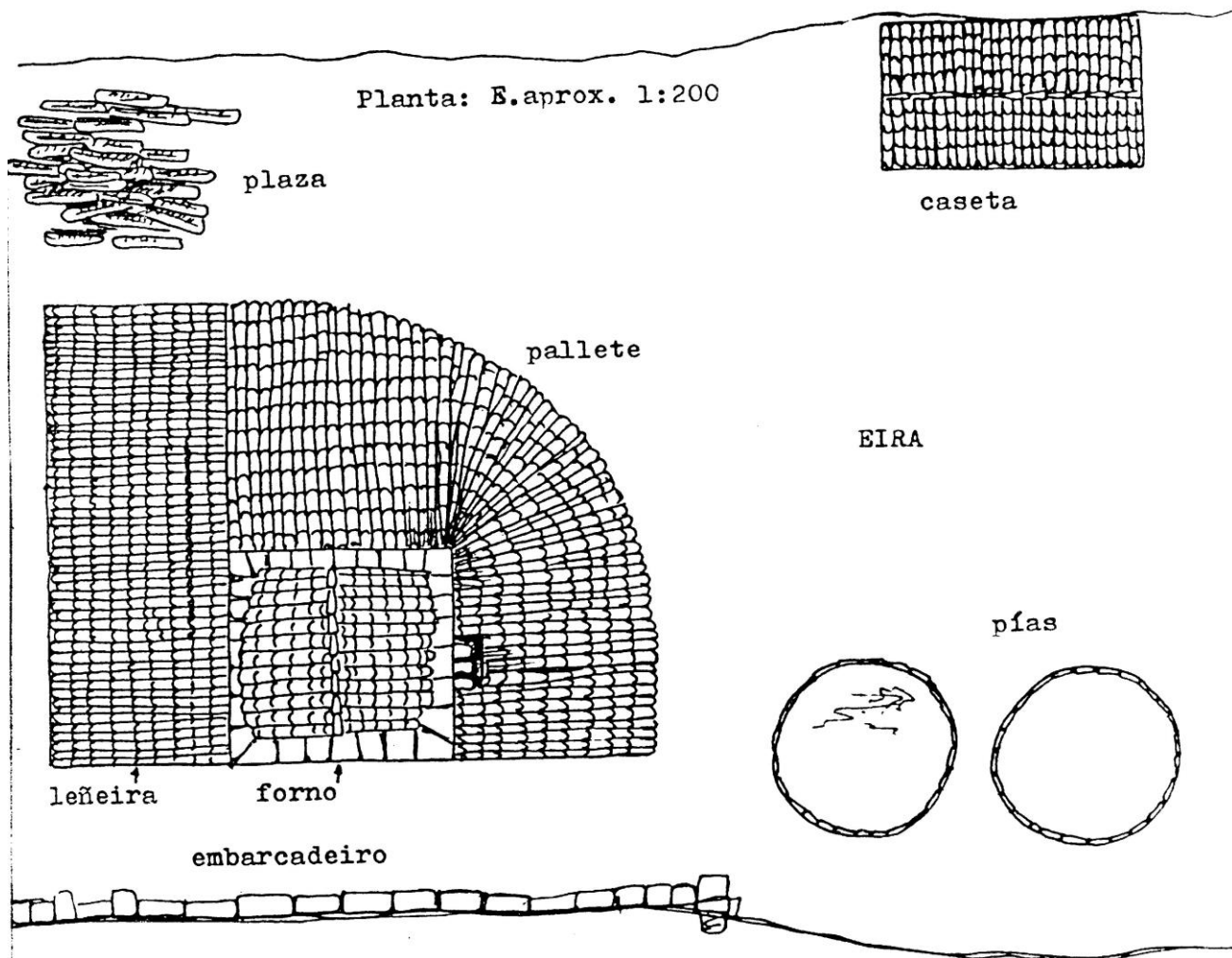

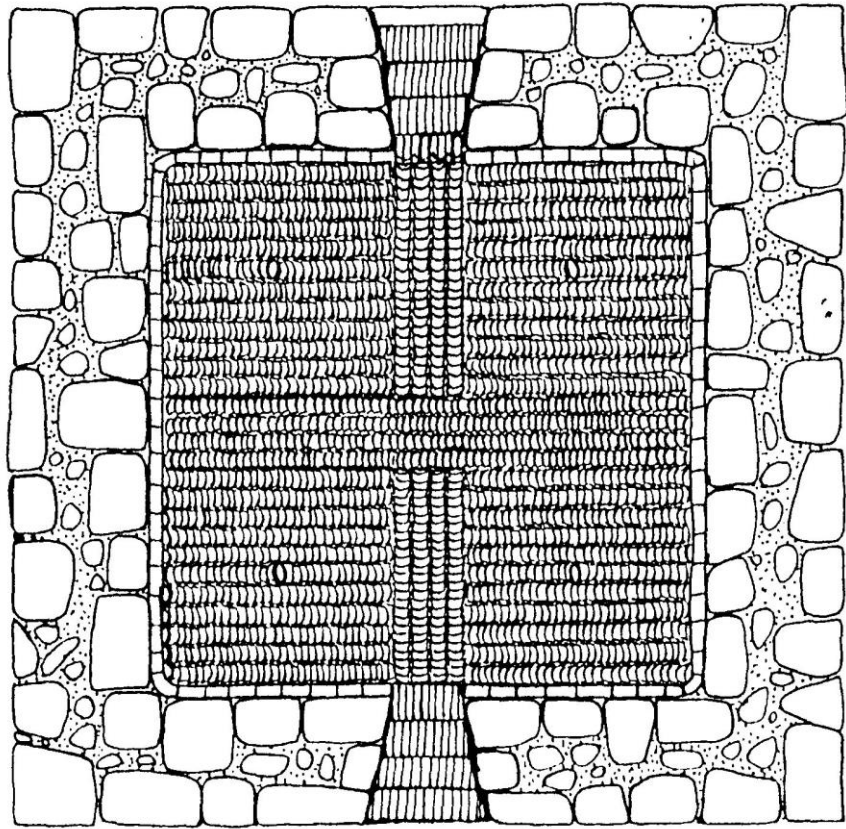

Forno

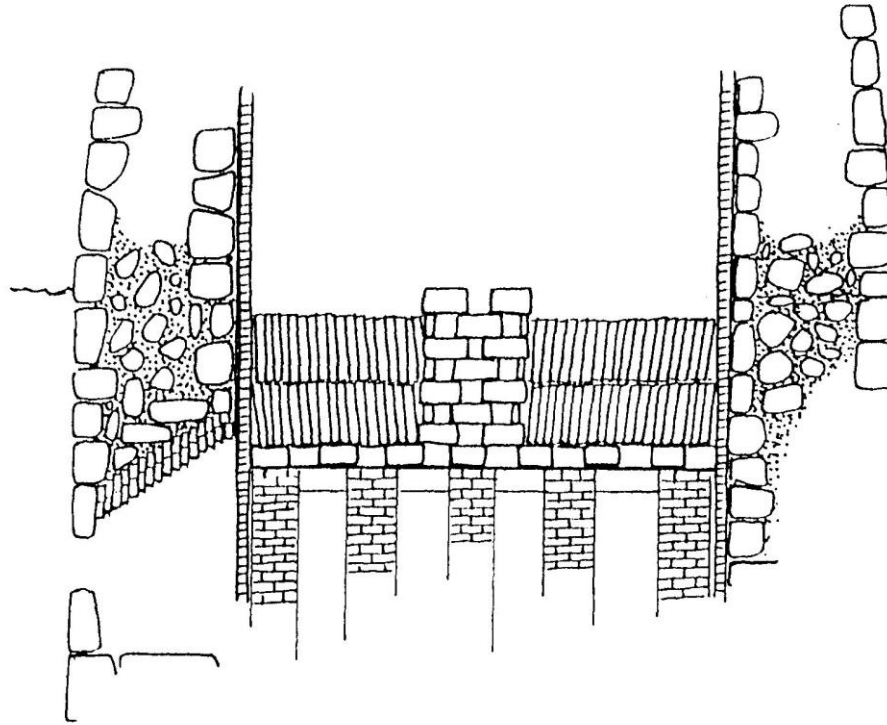

caldeira

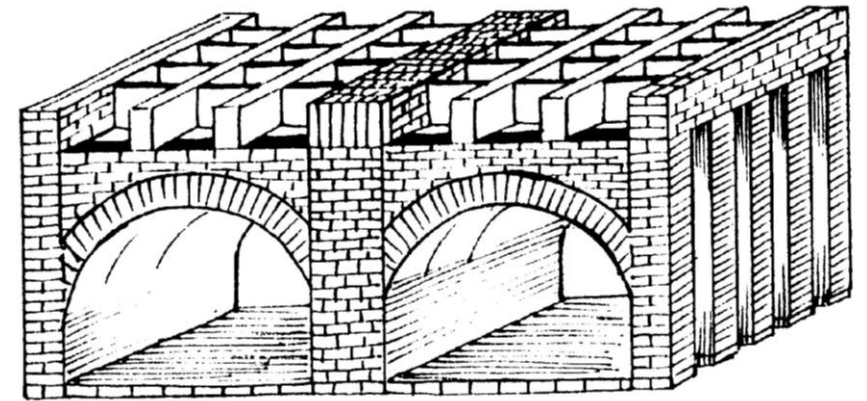

TELLEIRA DE VIEITES O FACHO (Castrelo, Cambados)

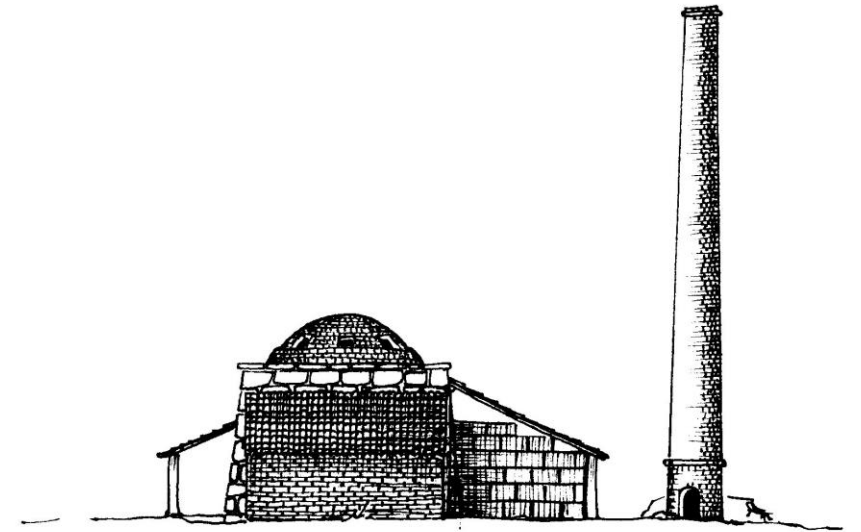
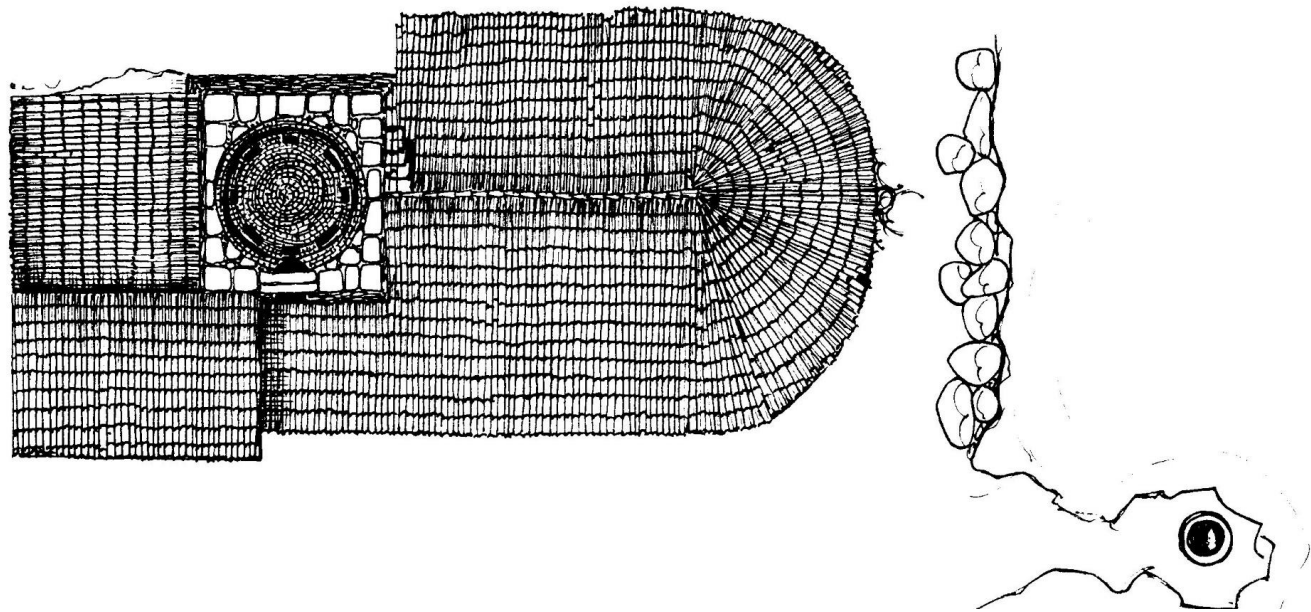
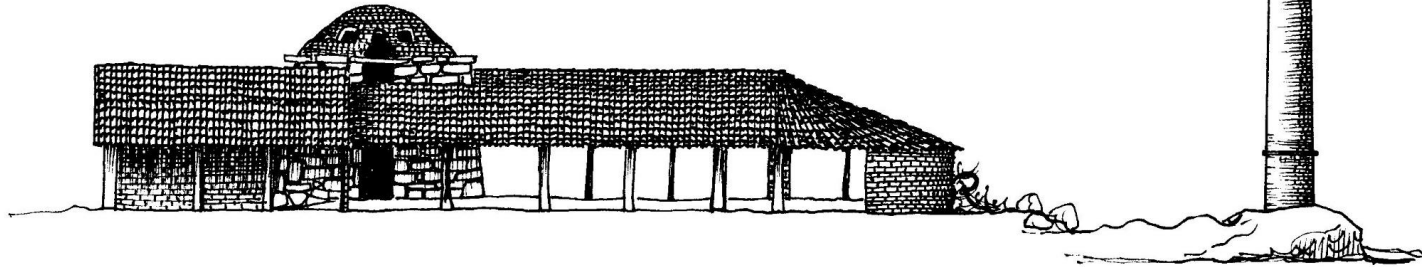

TELLEIRA DE ADOLFINA CAMIÑA O FACHO-CASTRELO-CAMBADOS

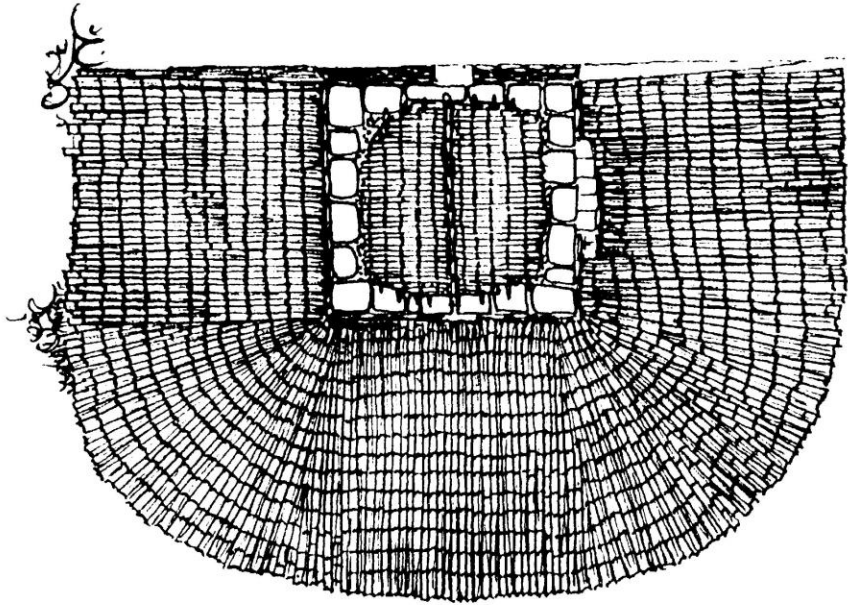

planta

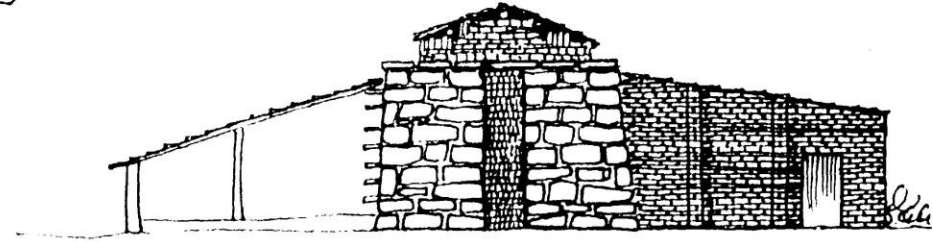

alzado leste



alzado norte

TELLEIRA DE MANUEL GONZÁLEZ
O FACHO-CASTRELO-CAMBADOS

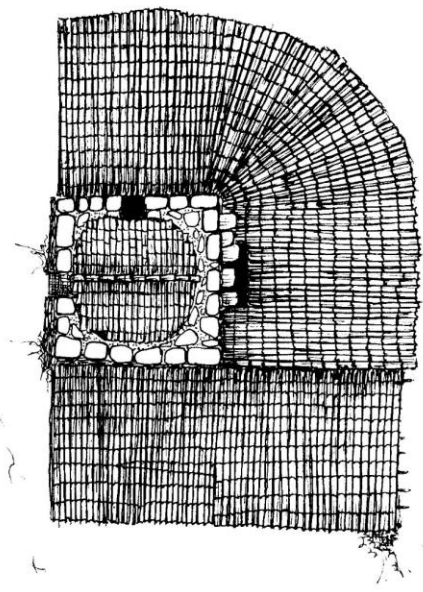
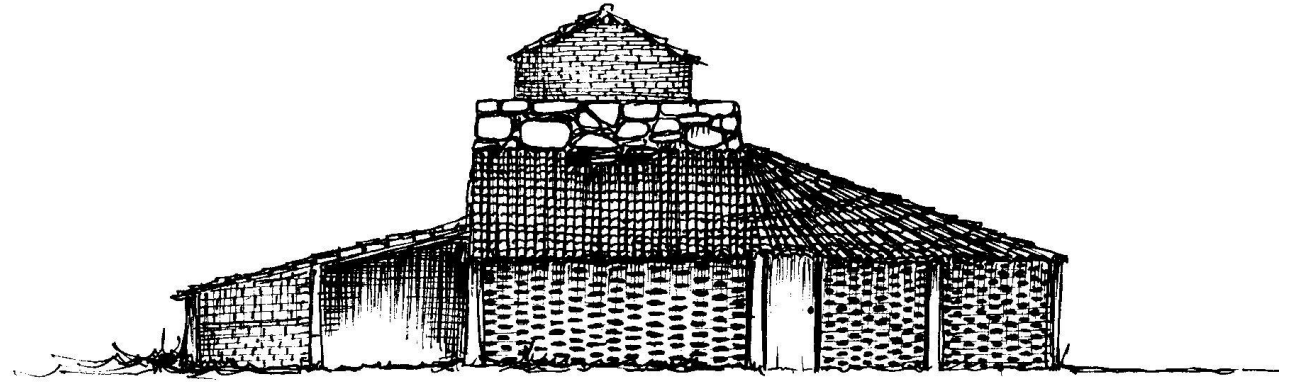
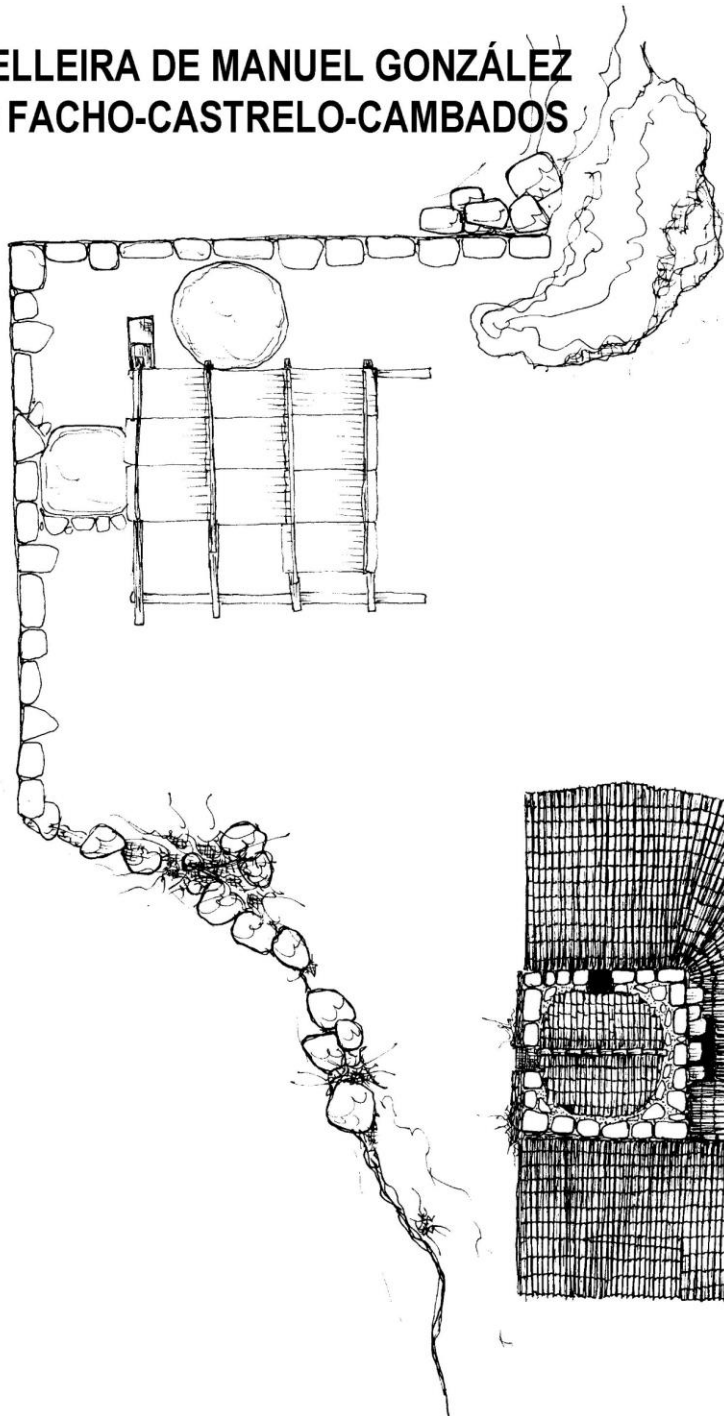

TELLEIRA DOS LORENZO BICO DA RAN-CASTRELO-CAMBADOS

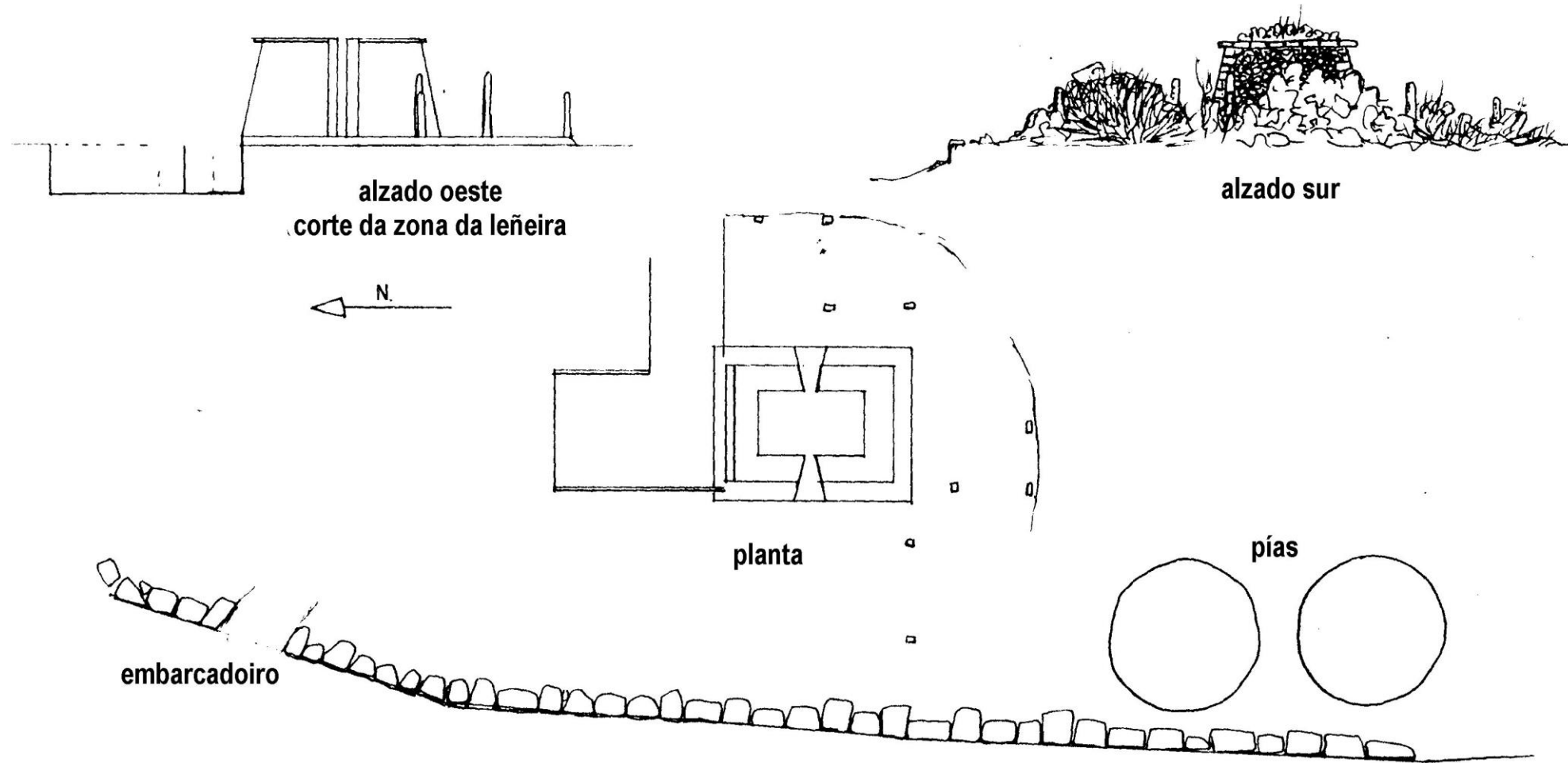

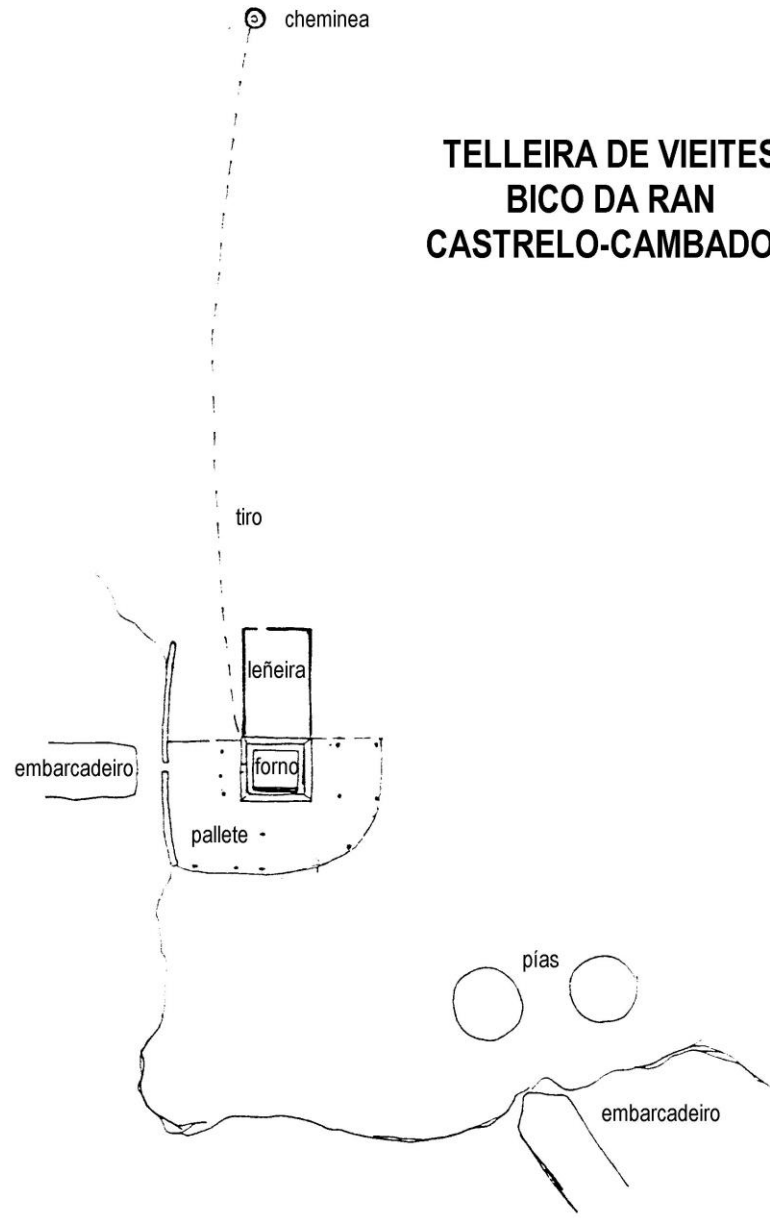
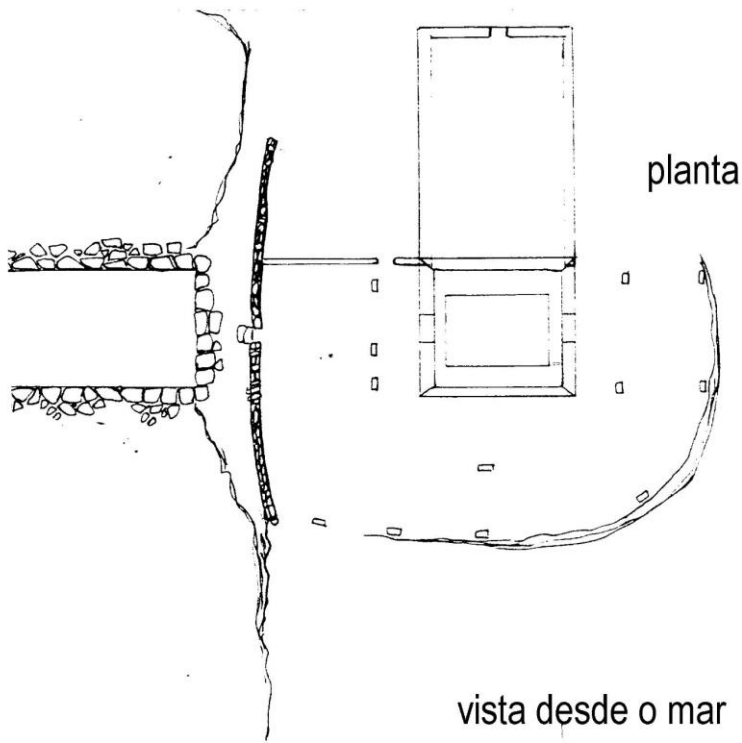
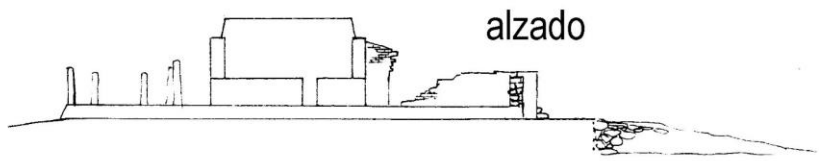

TELLEIRA DOS MOLEDO COUTO DE ABAIXO-CASTRELO-CAMBADOS

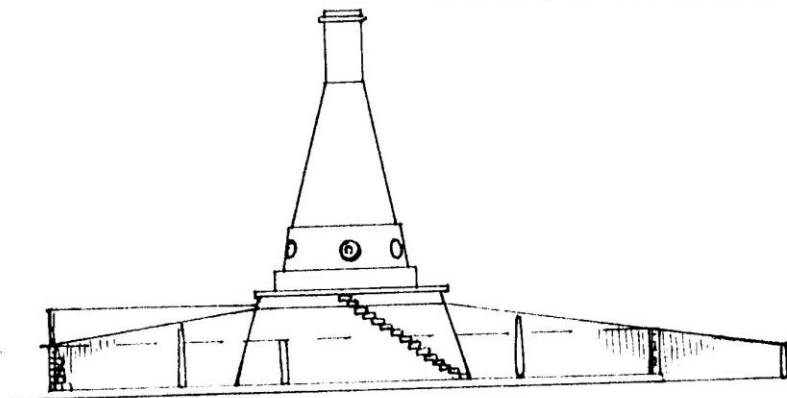

alzado leste

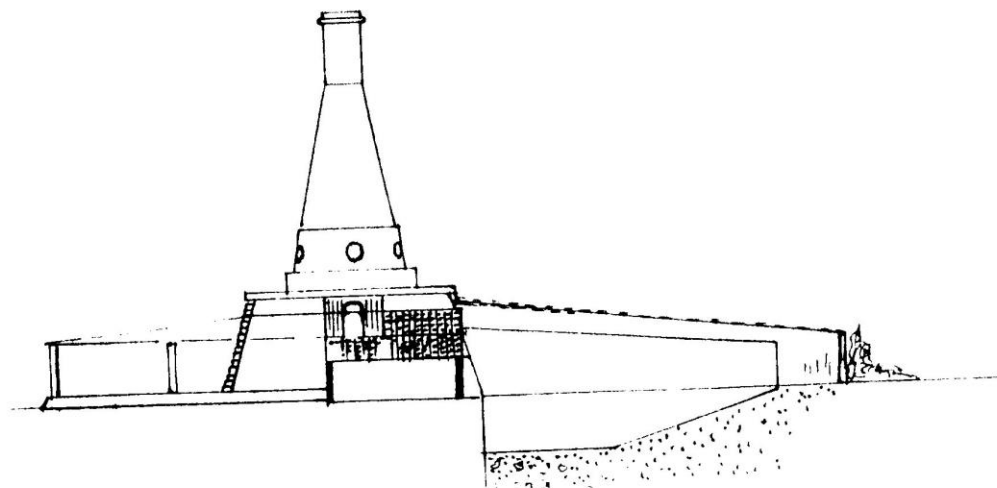

alzado norte, corte na zona da caldeira

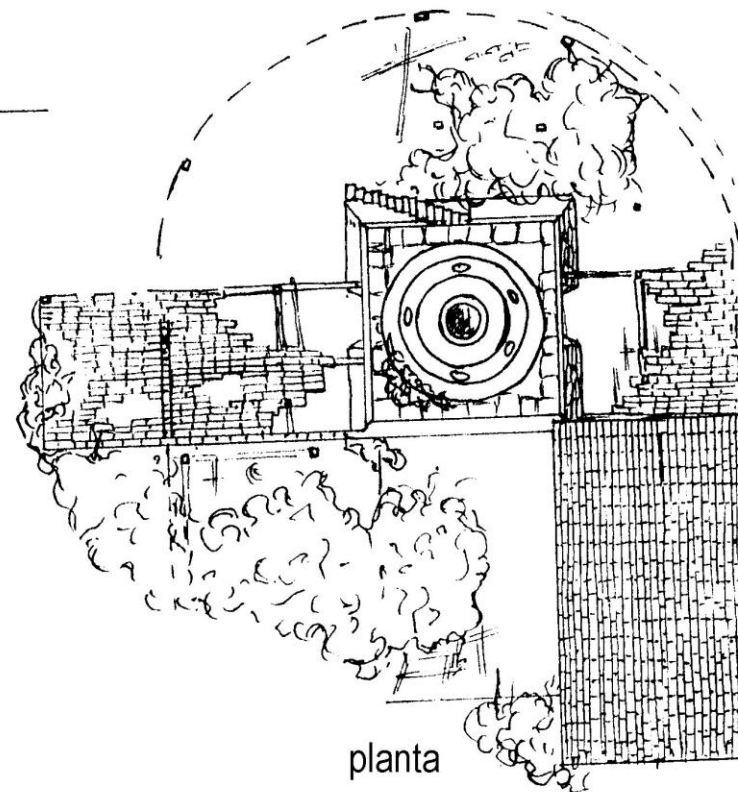
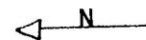

planta

TELLEIRA DO FRANCÓN CASTRELO-CAMBADOS



alzado norte



alzado oeste

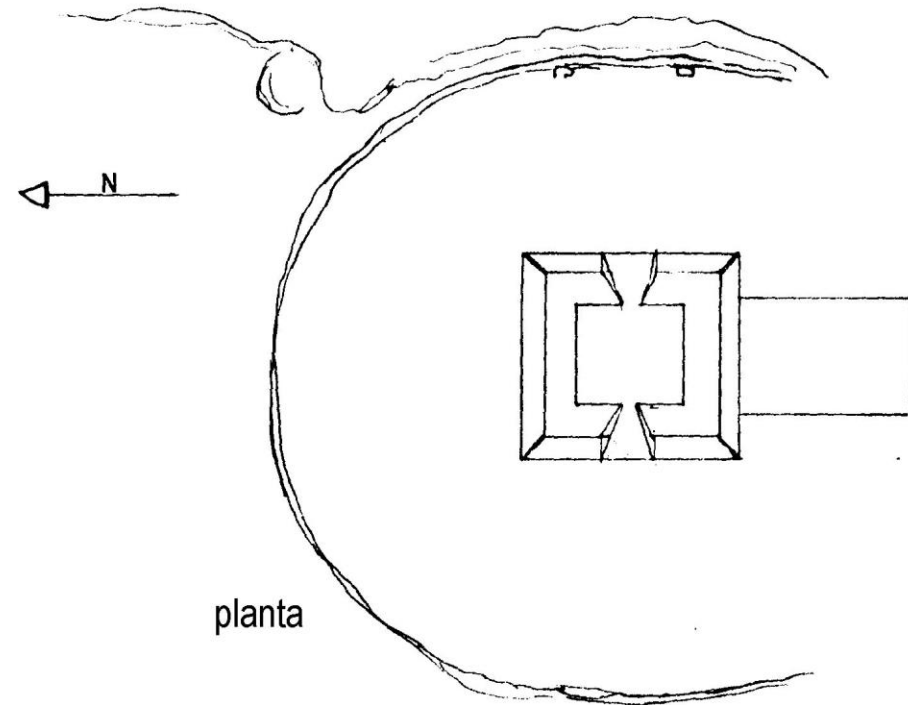

planta

TELLEIRA DE NOIA (Dena, Meaño)

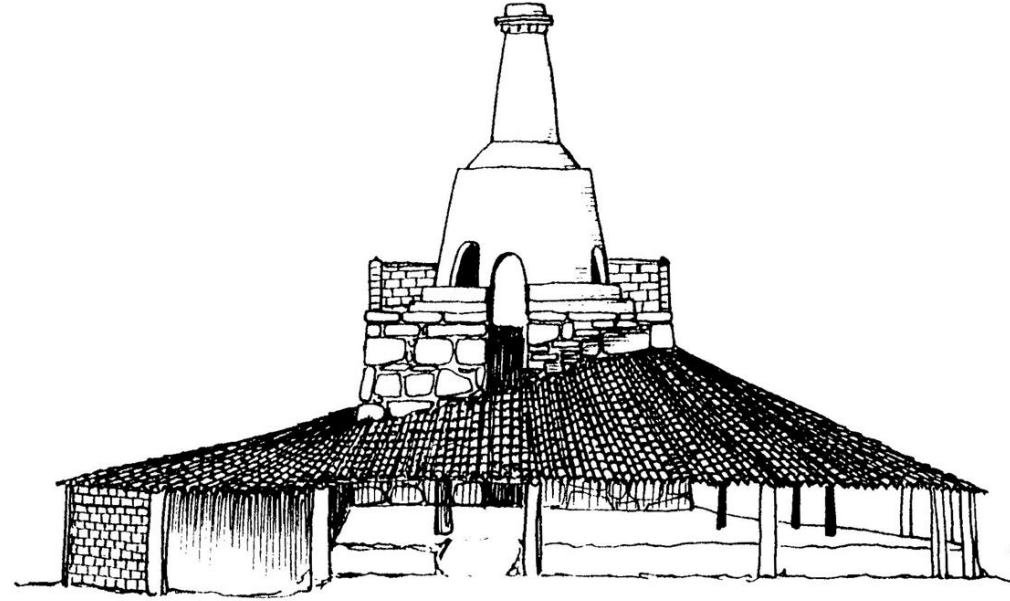
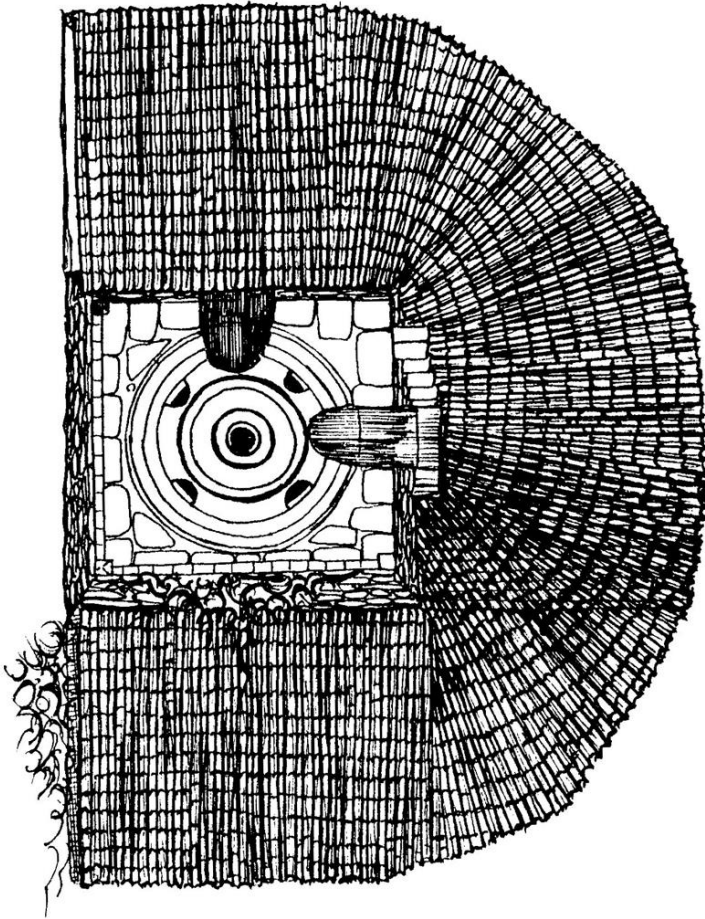

TELLEIRA DE ARDIA
O GROVE

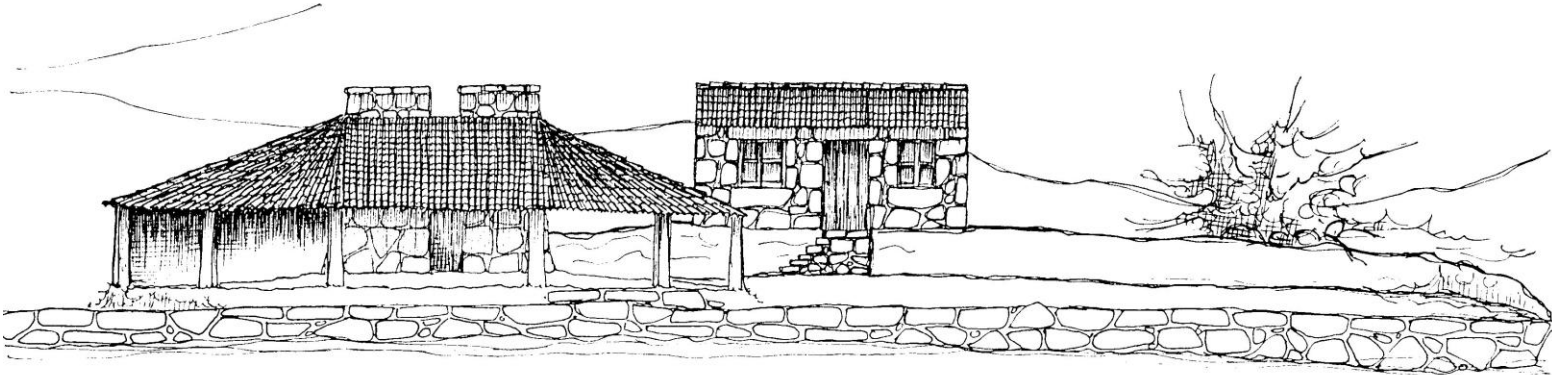
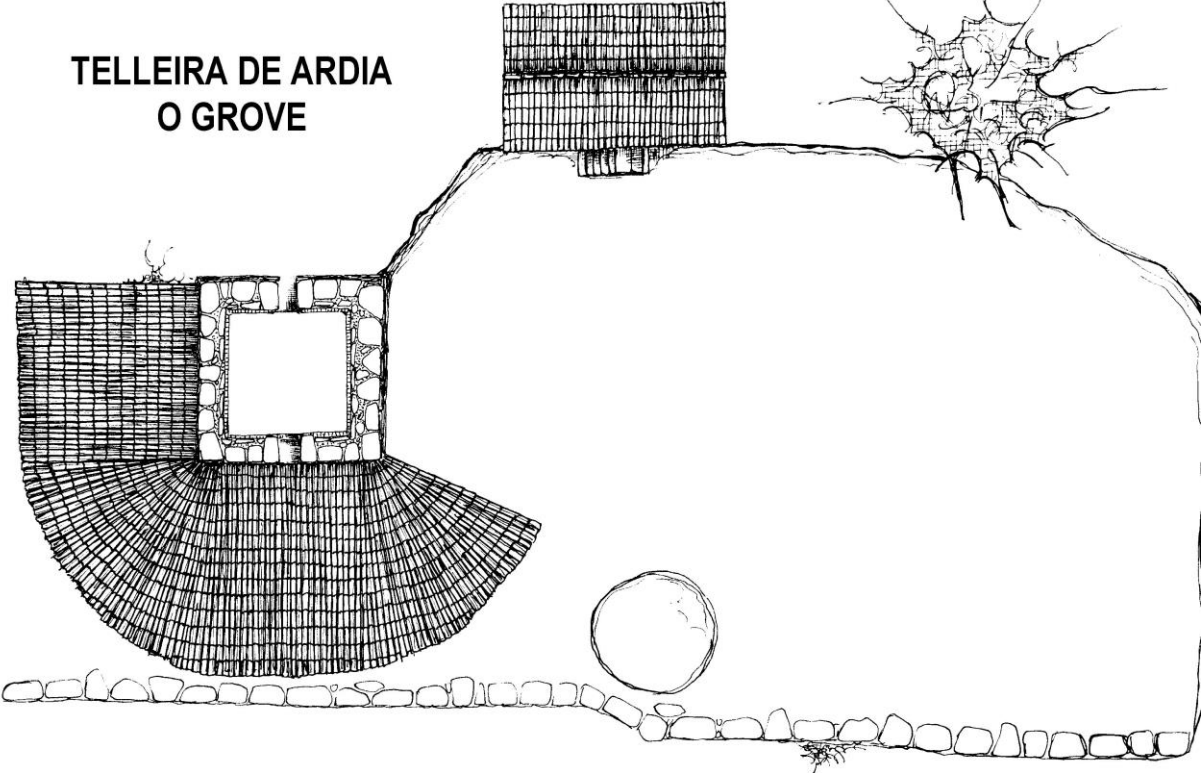

TELLEIRA DA RODA

Salvaterra

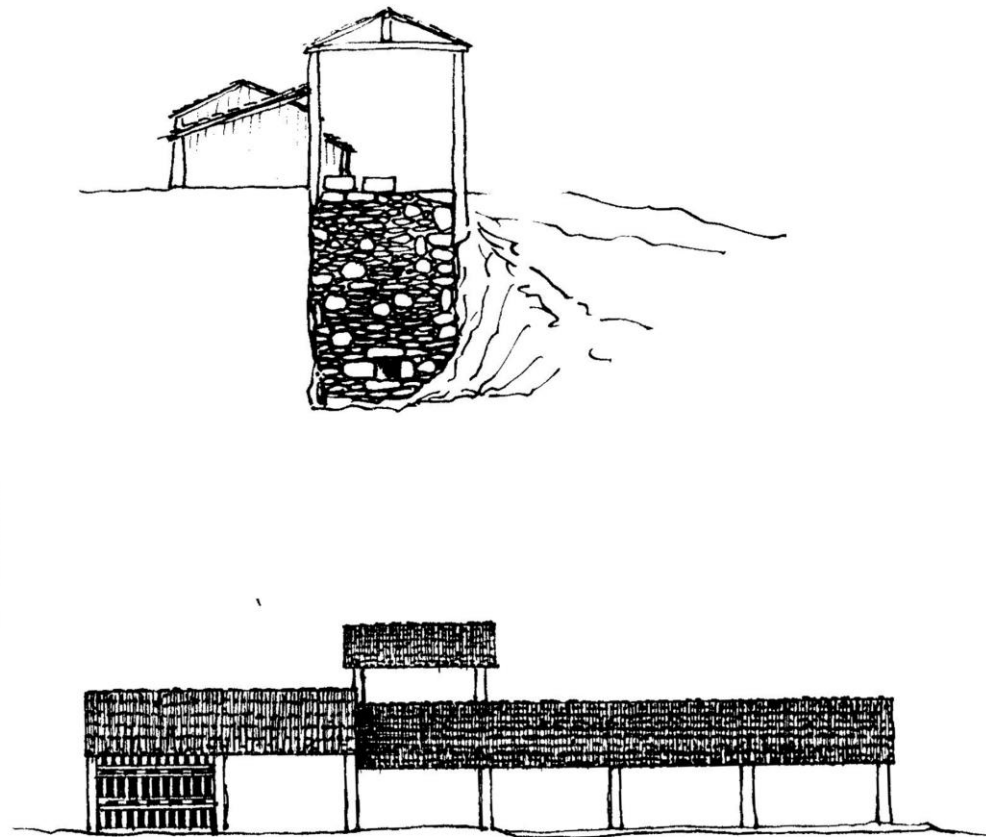
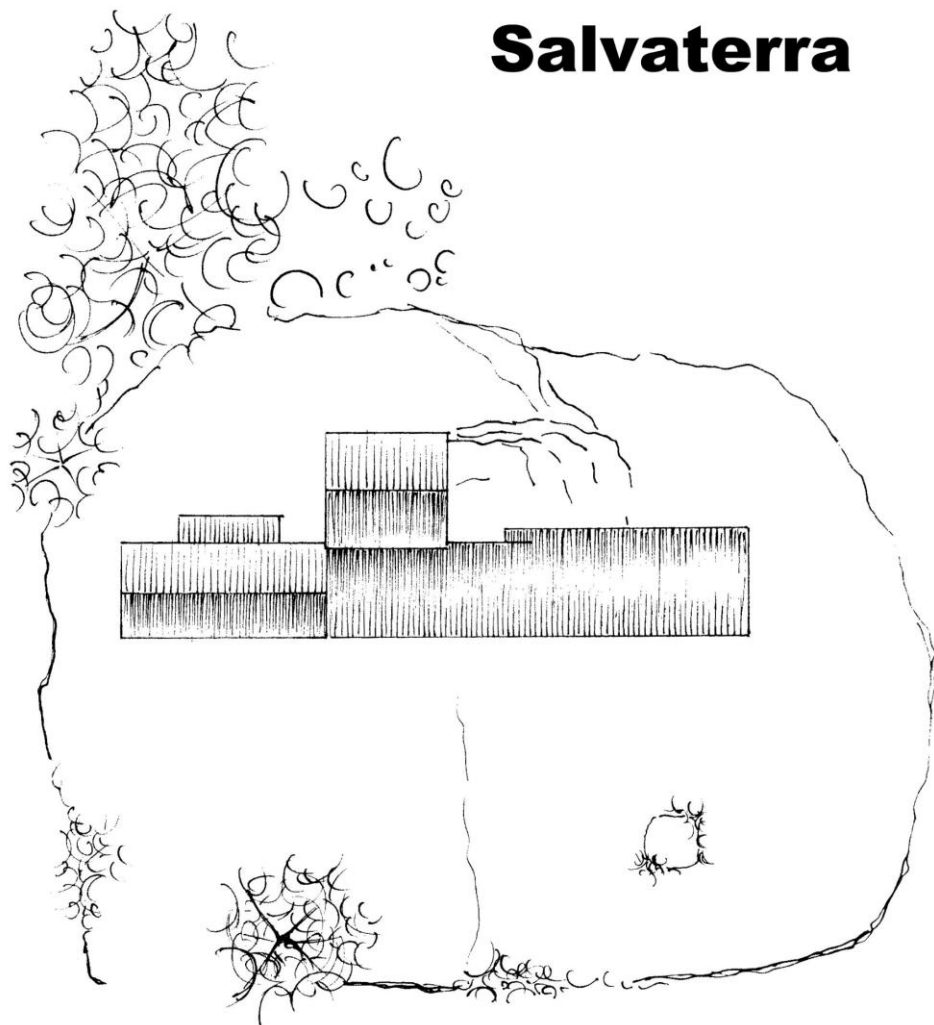

Aparellos e ferramentas da telleira

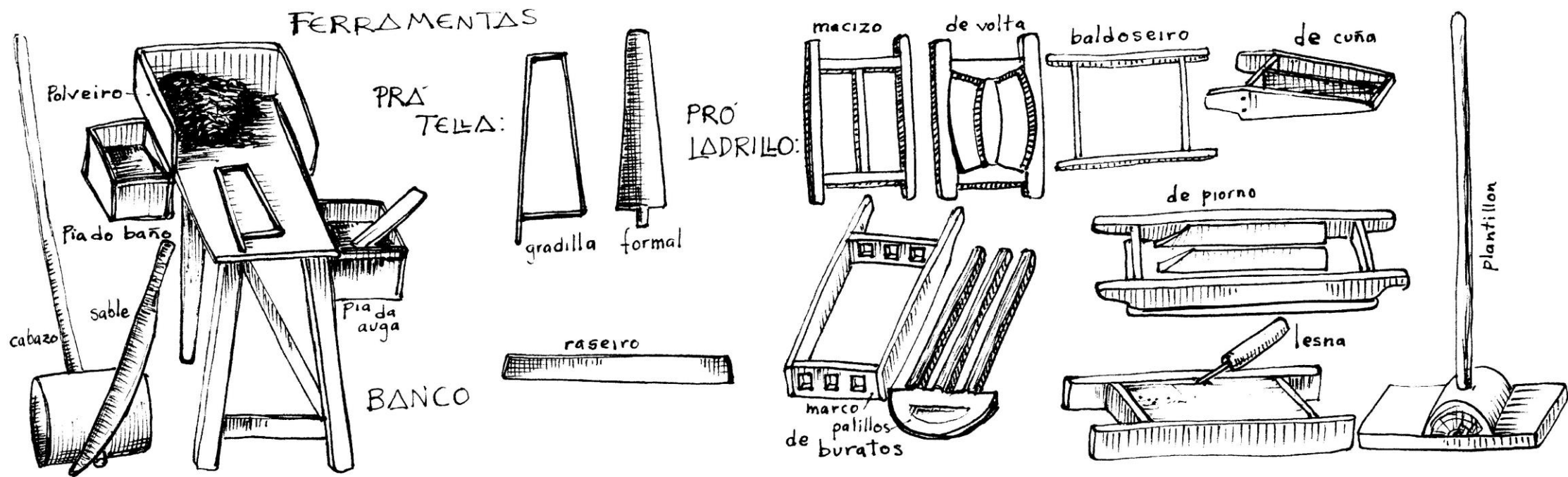

Aparellos para preparar o barro

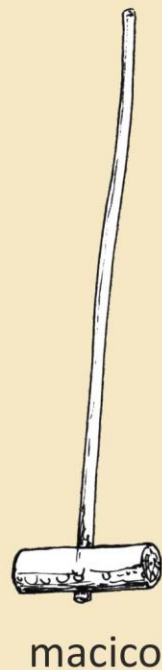

macico

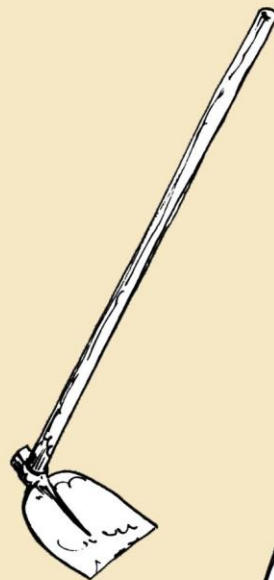

eixada



rodo

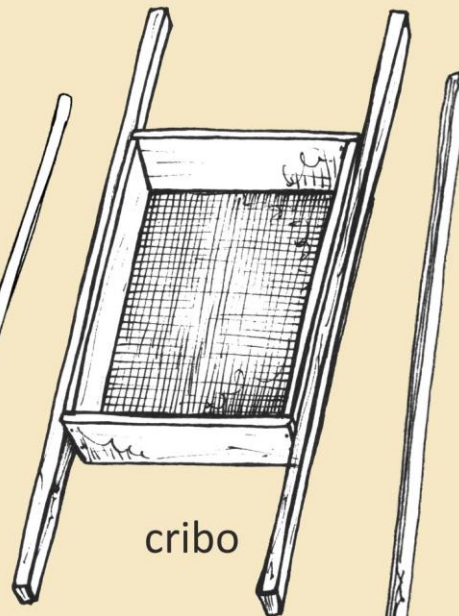

cribo



cabazo



sable

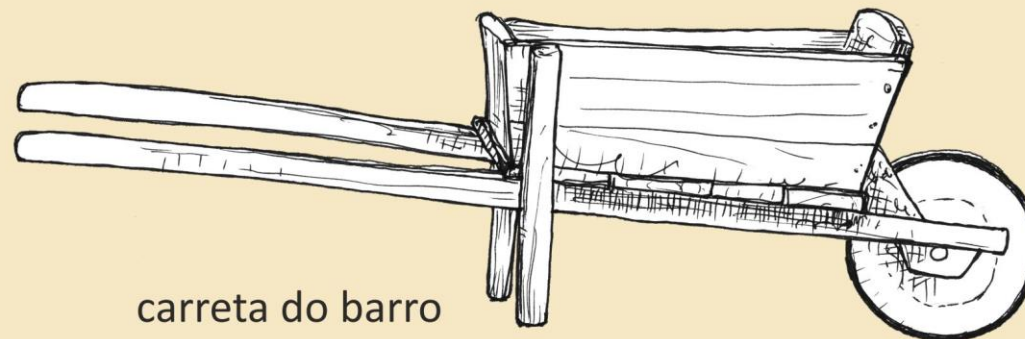

carreta do barro

Aparellos para preparar o barro

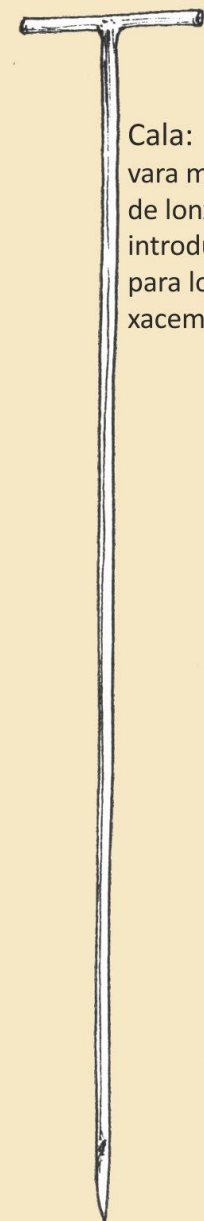
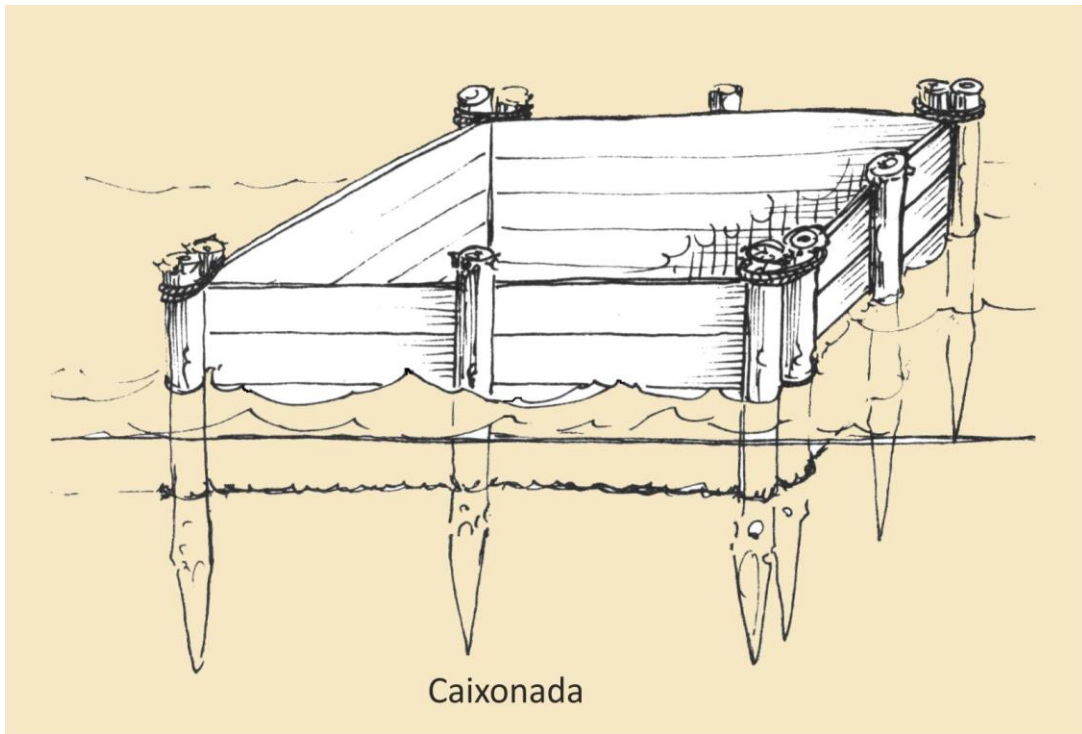

Cala:
vara metálica de 2 a 3 m
de lonxitude que se
introducía no terreo
para localizar os
xacementos de barro.

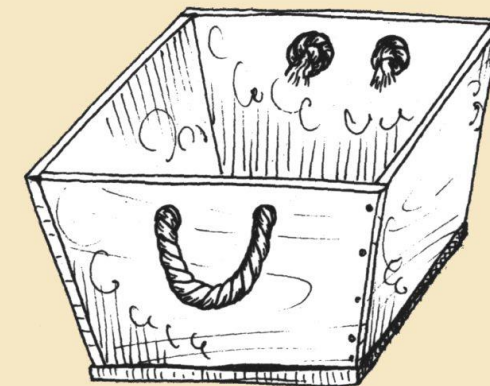
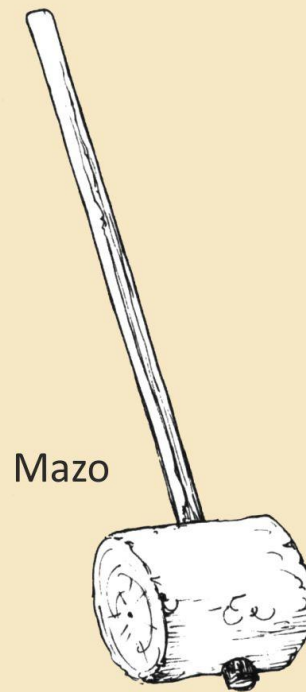

Tina

Banco do telleiro

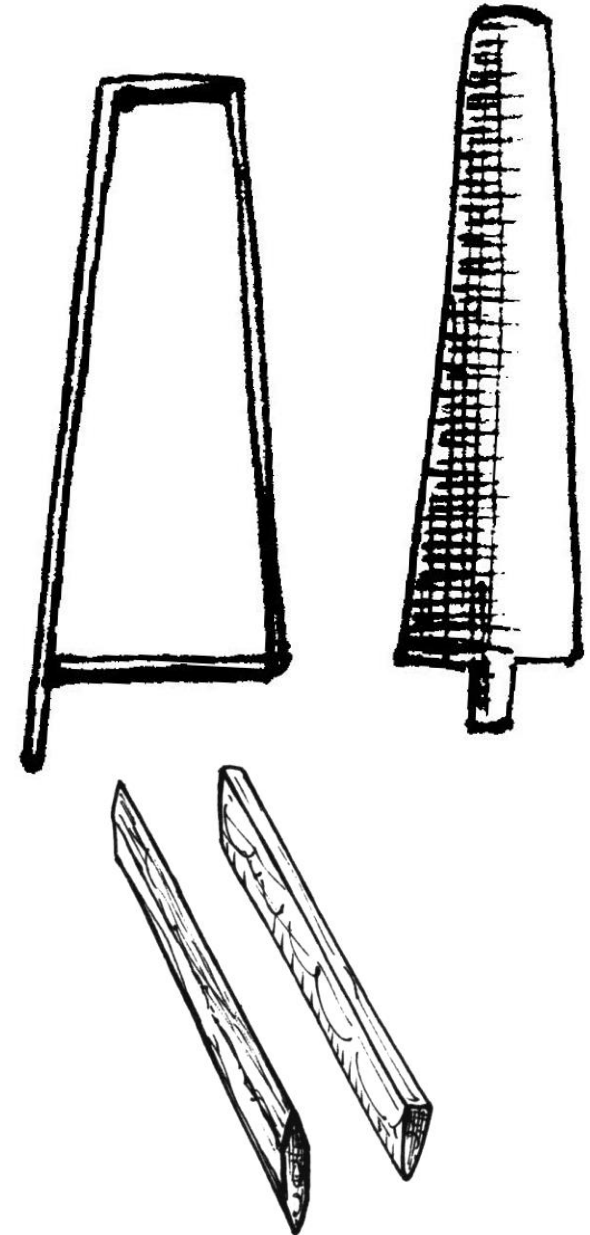
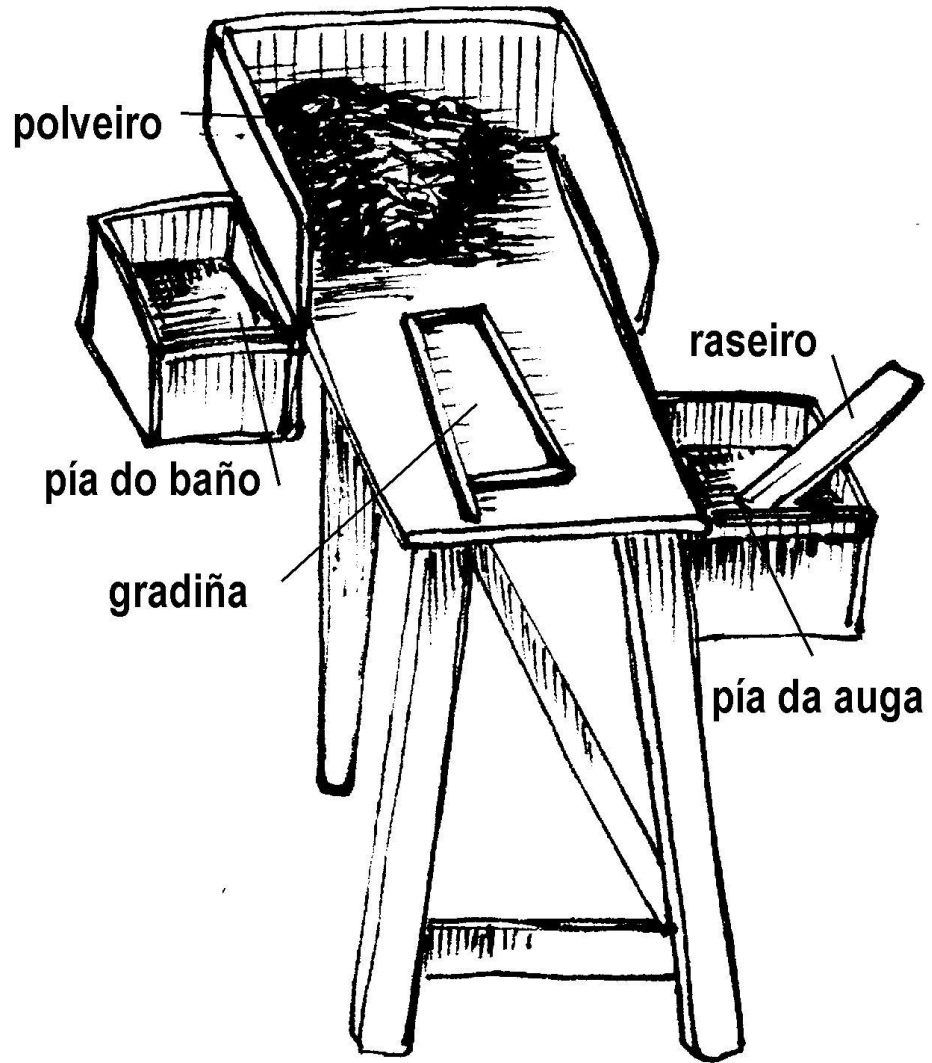

Tella de máquina

Boquilla
para facer
tella

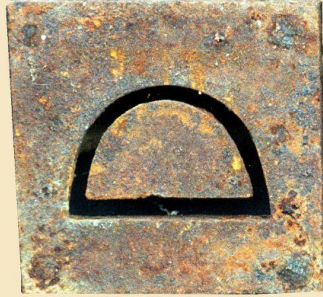

O formal da tella de máquina levaba o mango longo para poder manexalo mentres se desprazaba ao longo da canle da rebarbadora.

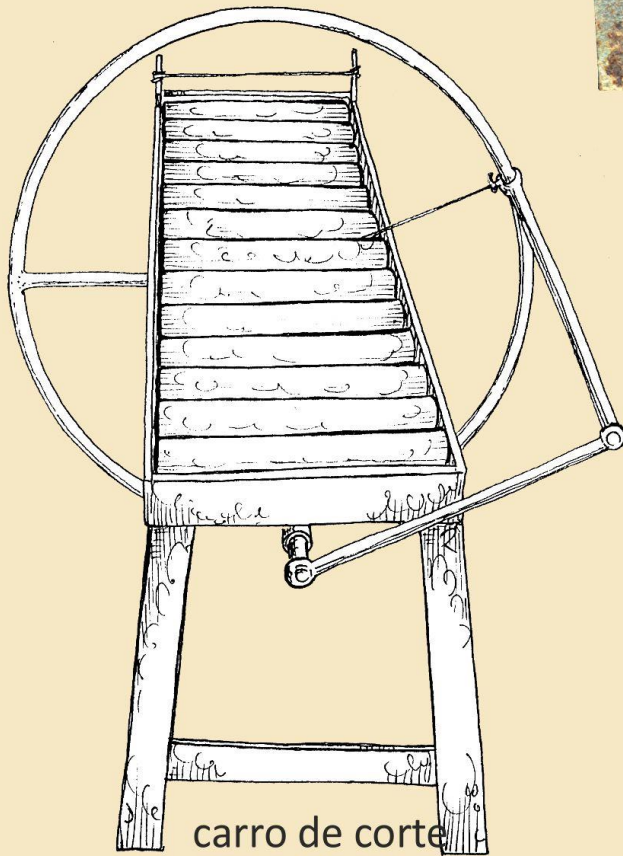

carro de corte

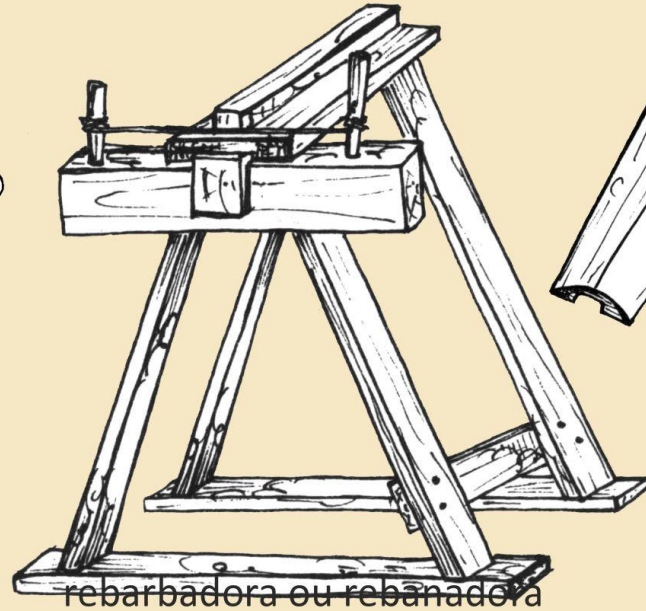

rebarbadora ou rebanadora

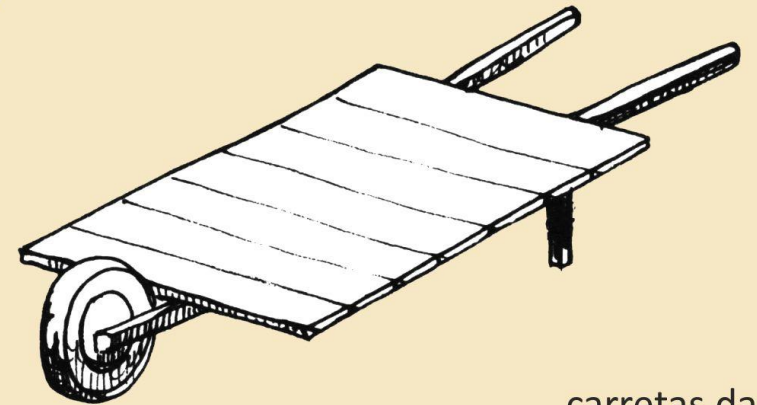

carretas da tella

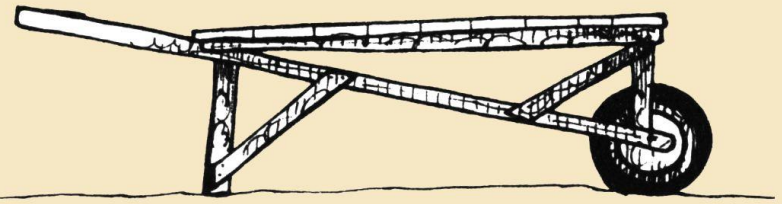

Ladrillos macizos

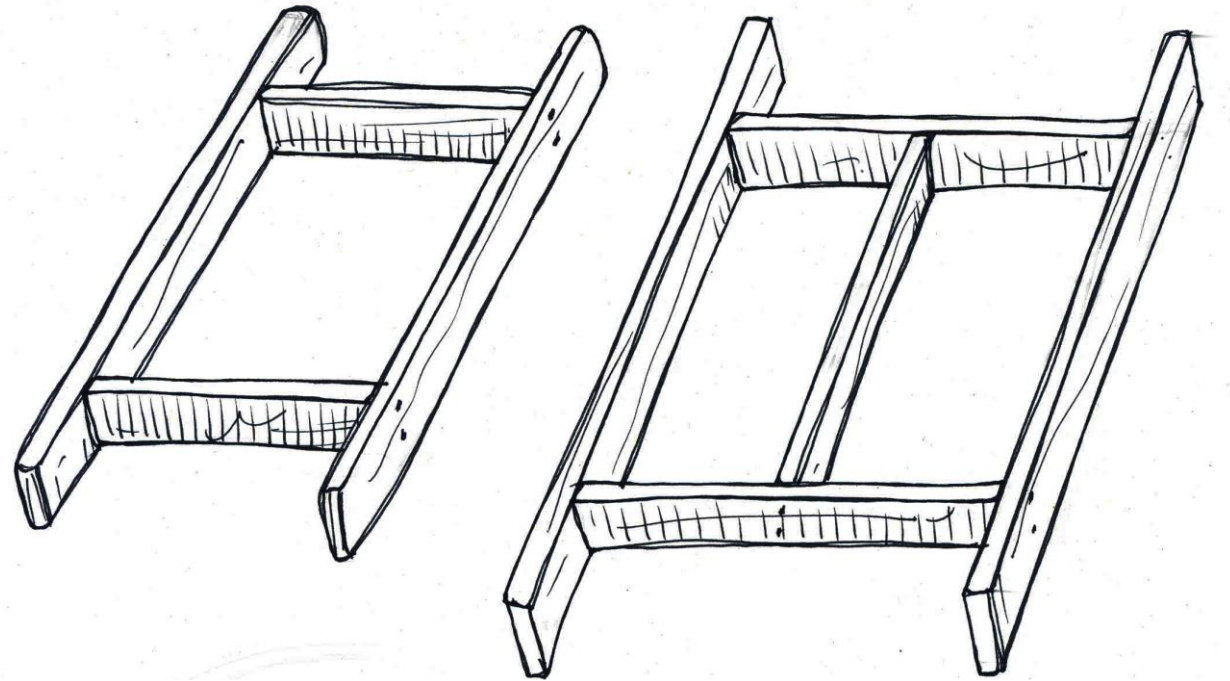
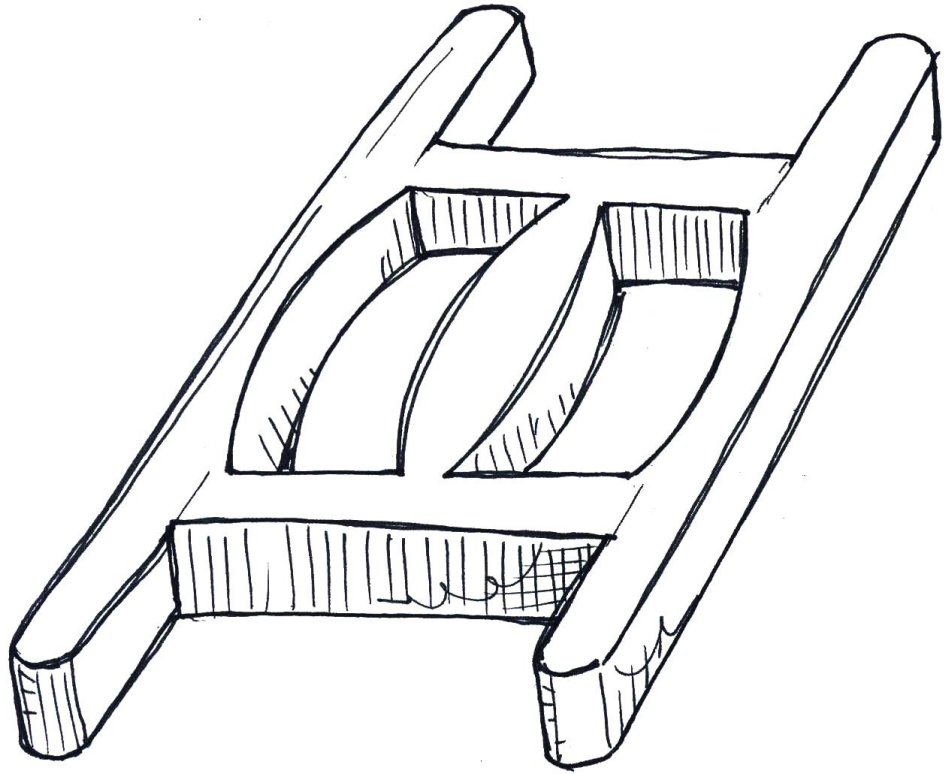

Ladrillos de hórreo

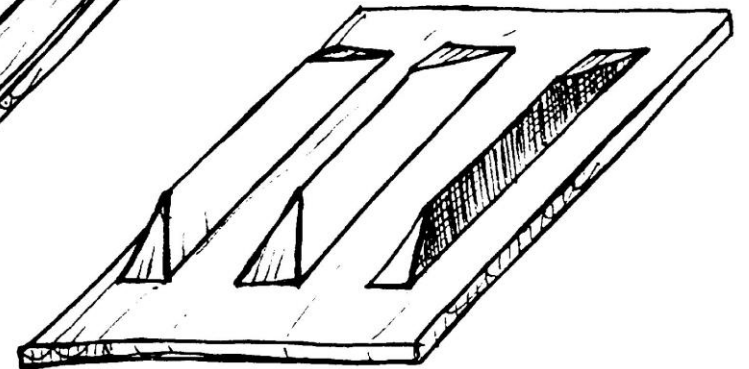
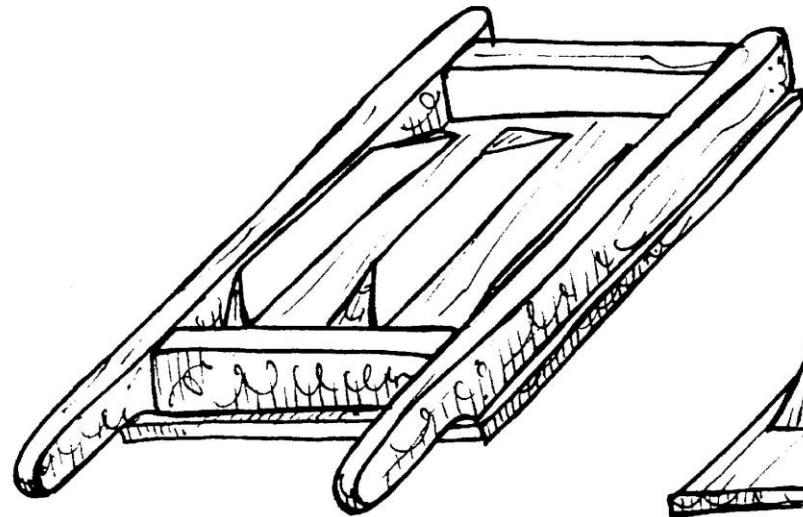

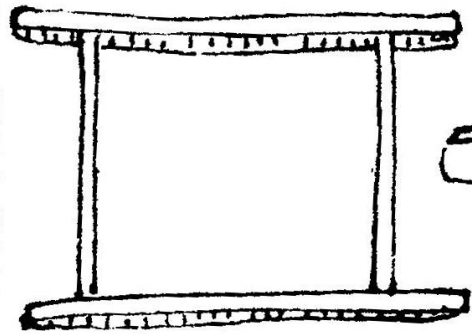

baldosa

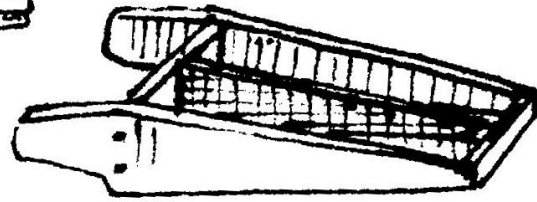

ladrillo de cuña

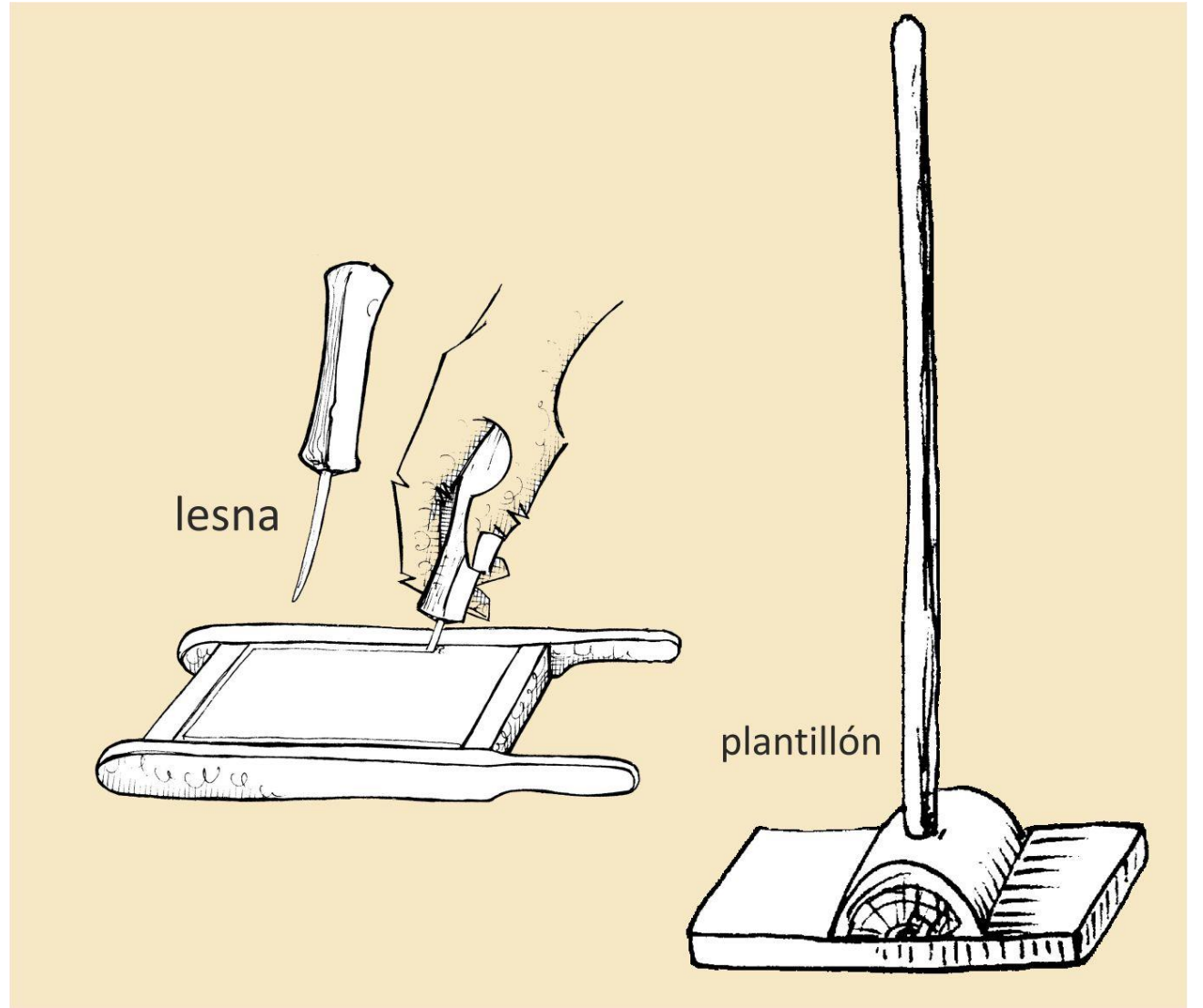

lesna

plantillón

Ladrillos de buratos

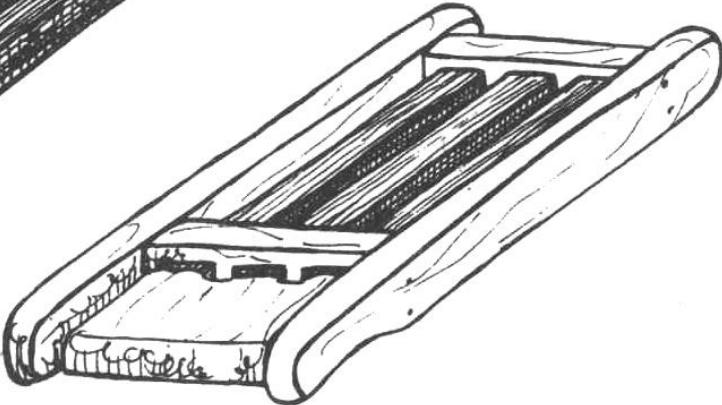
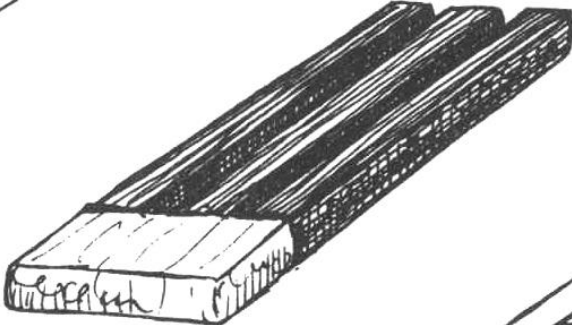
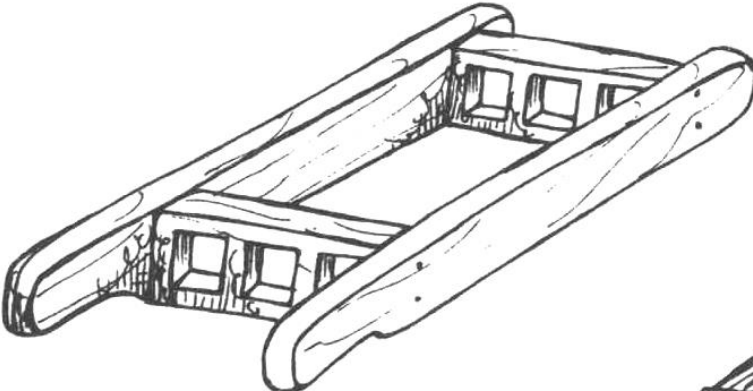
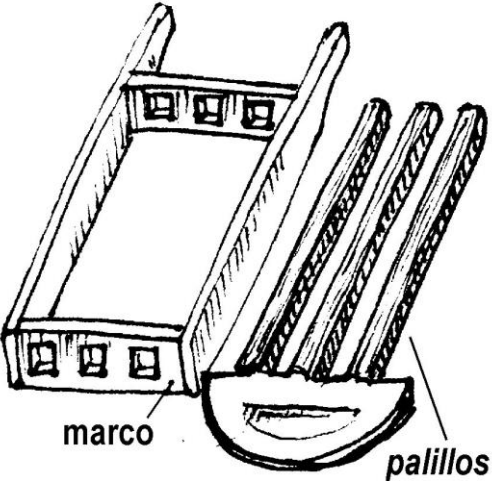

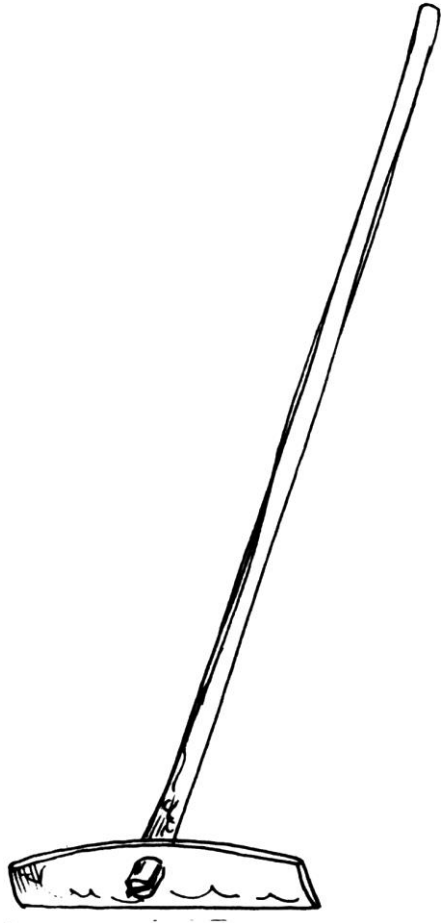

rodo pala limpar a eira

Aparellos para o forno

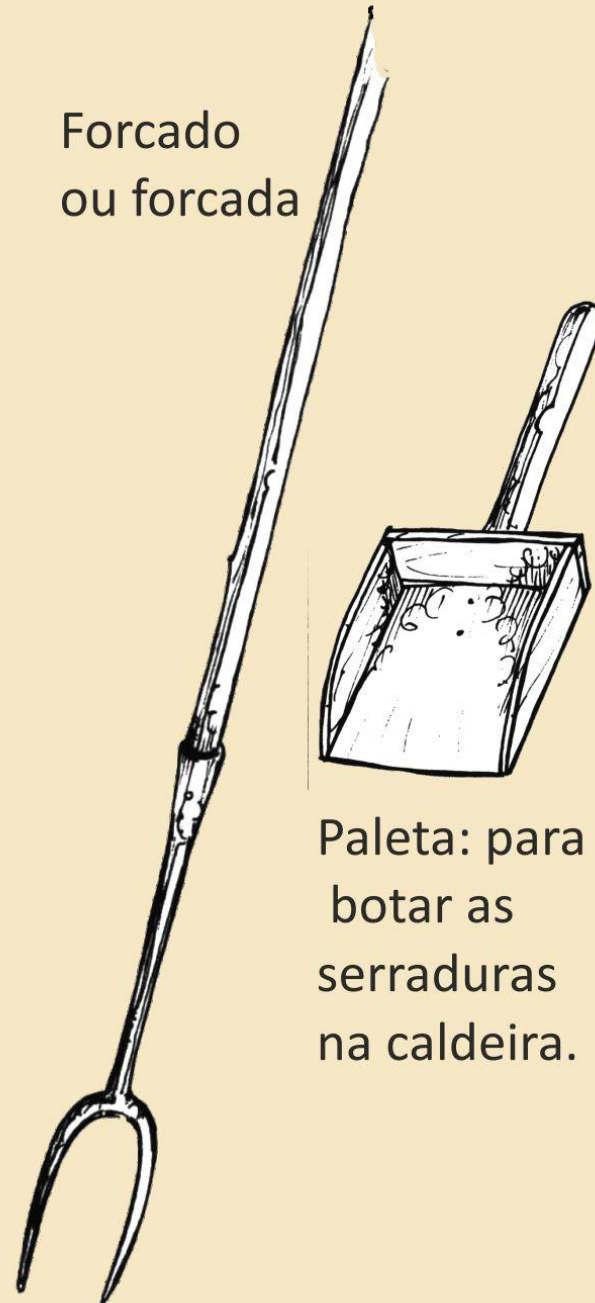

Forcado
ou forcada

Paleta: para
botar as
serraduras
na caldeira.